

**Soft closing mechanism SoftMove 80 for HAWA-Junior 80 gently decelerates and closes sliding doors.**

**Description**

The original: the new soft closing mechanism SoftMove 80 from HAWA AG is an accessory for all HAWA-Junior 80 systems and therefore suitable for both wood and glass sliding doors. It can be installed on the opening or closing side. Completely integrated in the top track, the soft closing mechanism SoftMove 80 gently decelerates sliding doors and draws them into their final position. A disposable drilling template included in the package guarantees precise, clean and simple installation.

**Features of the soft closing mechanism SoftMove 80 for HAWA-Junior 80**

- Minimum door width for one-sided damping: 690 mm (2'3 <sup>5</sup>/<sub>32</sub>" )
- Minimum door width for two-sided damping: 1030 mm (3'4 <sup>9</sup>/<sub>16</sub>" )
- Invisibly integrated in the top track
- High-class hydraulic metal damper with a diameter of 14 mm guarantees high quality and a long life-cycle
- Continuous gentle deceleration and closing with no door spring-back
- Utilisable with all HAWA-Junior 80 sliding door systems
- Available as a set: HAWA-Junior 80 set including a soft closing mechanism SoftMove 80

**Suitable for**

Wood  
HAWA-Junior 80/Z  
HAWA-Junior 80/B

Glass  
HAWA-Junior 80/GP  
HAWA-Junior 80/G  
HAWA-Junior 80/GV  
HAWA-Junior 80/GL  
HAWA-Junior 80/GS

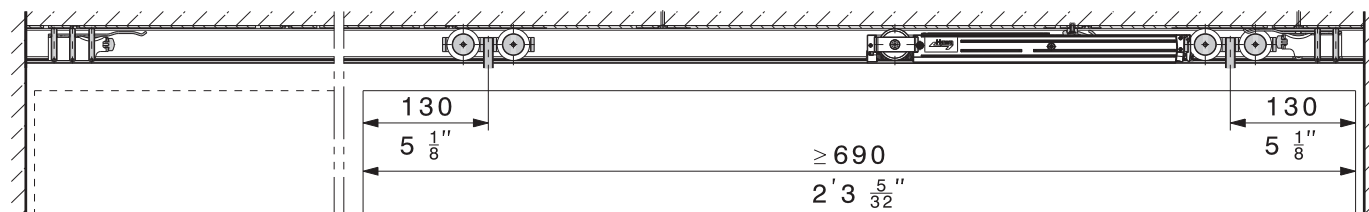

One-sided damping

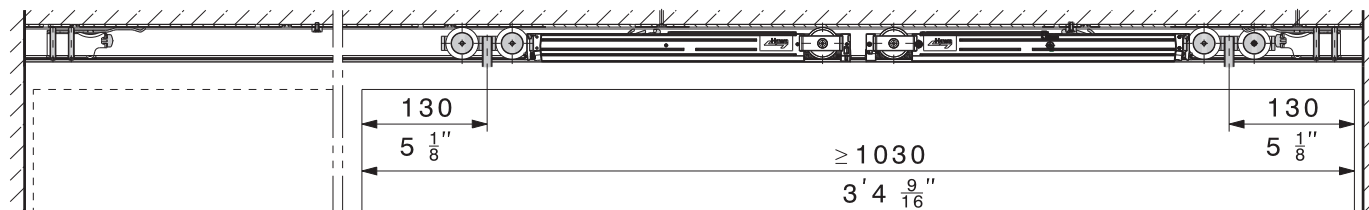

Two-sided damping

Subject to modification. Metric specifications are exact. Inches are approximate.

## Soft closing mechanism SoftMove 80 for HAWA-Junior 80

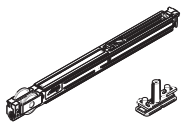
	Soft closing mechanism SoftMove 80 for HAWA-Junior 80	code 22444
--	---	---------------



## Set with soft closing mechanism SoftMove 80 for HAWA-Junior 80 for 1 wooden sliding door, without top track

	code
HAWA-Junior 80/Z, Set for 1 door, with 1 soft closing mechanism SoftMove 80	23087
HAWA-Junior 80/Z, Set for 1 door, with 2 soft closing mechanisms SoftMove 80	23088
HAWA-Junior 80/B, Set for 1 door, with 1 soft closing mechanism SoftMove 80	23089
HAWA-Junior 80/B, Set for 1 door, with 2 soft closing mechanisms SoftMove 80	23090
HAWA-Junior 80/GP, Set for 1 door, with 1 soft closing mechanism SoftMove 80	23091
HAWA-Junior 80/GP, Set for 1 door, with 2 soft closing mechanisms SoftMove 80	23092

## Fitting sets for HAWA-Adapto 80, with countersunk screws

	mm/inch	code
Fitting sets for HAWA-Adapto 80, with countersunk screws	to 2500 (8'2 $\frac{7}{16}$ " )	22841
	2501 to 4000 (8'6 $\frac{3}{8}$ " to 13'1 $\frac{1}{2}$ " )	22842
	4001 to 6000 (13'5 $\frac{7}{16}$ " to 19'8 $\frac{7}{32}$ " )	22843

## Sets comprising

	mm/inch	22841	22842	22843	code
	1 ( $\frac{1}{16}$ " )	2	2	3	19398
	2 ( $\frac{3}{32}$ " )	2	2	3	19399
	3 ( $\frac{1}{8}$ " )	2	2	3	19400
	5 ( $\frac{7}{32}$ " )	4	4	6	19401
	Special countersunk screws, 60 x 21 mm (2 $\frac{3}{8}$ " x $\frac{27}{32}$ " ), set of 10 pieces	1	2	3	22844

## Soft closing mechanism SoftMove 80 for HAWA-Junior 80

The SoftMove 80 soft closing mechanism is available as a stand-alone unit or as a component of a HAWA-Junior 80/Z, 80/B or 80/GP set. Please also order a floor guide and cover caps for HAWA-Junior 80/GP systems. See HAWA-Junior 40-80-120-160/GP for details.

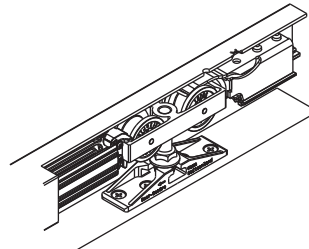

HAWA-Junior 80/Z

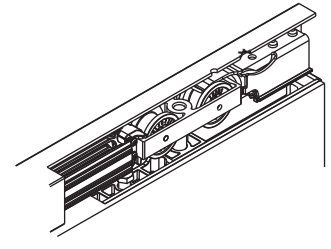

HAWA-Junior 80/B

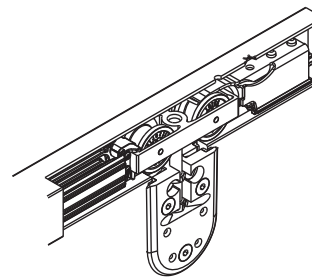

HAWA-Junior 80/GP

## Fitting sets with countersunk screws to HAWA-Adapto 80

Fitting sets with countersunk screws need to be ordered for the installation of HAWA-Junior top tracks with an integrated soft closing mechanism SoftMove 80. See HAWA-Adapto 80-120 for details.

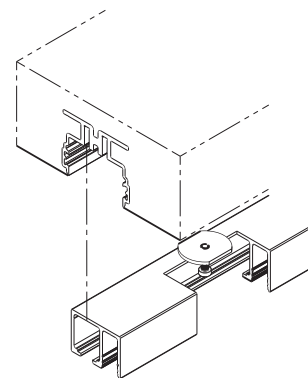

## Planing/installation – Soft closing mechanism SoftMove 80

For planning and installation purposes, please use the installation drawing code 22708. (→ hawa.ch → Productfinder)